



KLAUS Multiparking GmbH
Hermann-Krum-Straße 2
D-88319 Aitrach
Fon +49 (0) 75 65 508-0
Fax +49 (0) 75 65 508-88
info@multiparking.com
www.multiparking.com

PRODUCT DATA



singleup 2015

2500 kg

Garage without door (basement garage)

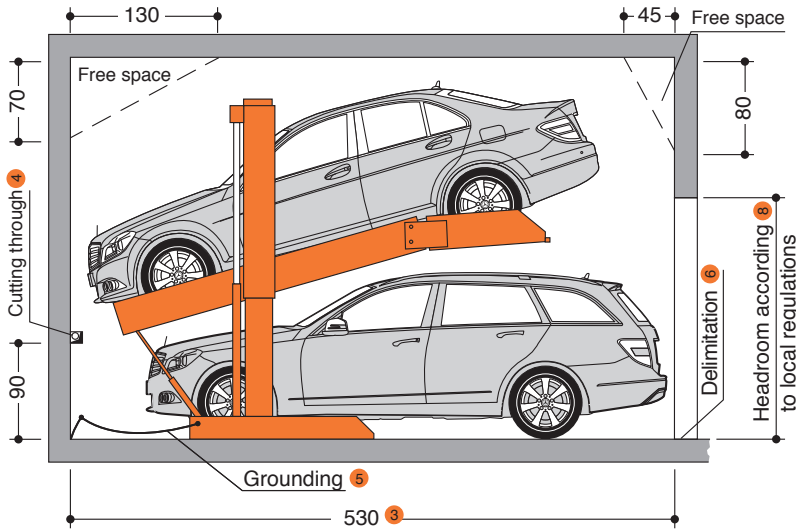

Dimensions

All space requirements are minimum finished dimensions.

Tolerances for space requirements ± 3 mm. ¹
Dimensions in cm.

EB (single platform) = 2 vehicles

Suitable for

Standard passenger cars:
Limousine, station wagon, SUV, van
according to clearance and maximal
surface load.

- width 190 cm
- weight max. 2500 kg
- wheel load max. 625 kg

Clearance profile Limousine (L)

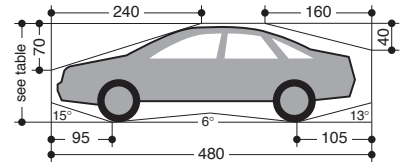

Clearance profile Station wagon (S)

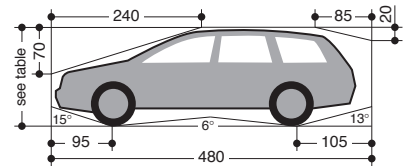

! Before lowering the platform, the vehicle parked on the lower parking space must be driven off!

Version 1: above backward; below forward

2015-155

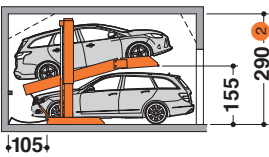

height	car height above (L+S)	car height below (L+S)
290	150	150

2015-170

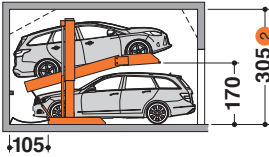

height	car height above (L+S)	car height below (L+S)
305	150	160

Version 2: above and below forward

2015-155

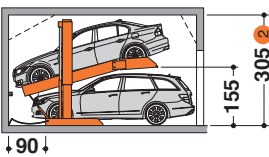

height	car height above (L)	car height below (L+S)
305	150	150

2015-170

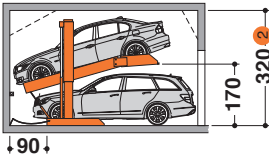

height	car height above (L)	car height below (L+S)
320	150	160

2015-155

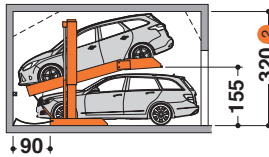

height	car height above (L+S)	car height below (L+S)
320	150	150

2015-170

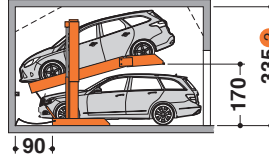

height	car height above (L+S)	car height below (L+S)
335	150	160

- 1 To follow the minimum finished dimensions, make sure to consider the tolerances according to VOB, part C (DIN 18330 and 18331) and the DIN 18202.
- 2 If a higher ceiling height is available higher cars can be parked.
- 3 If the total length is greater, the max. vehicle length for the lower parking space increases accordingly.
- 4 For dividing walls: cutting through 10 x 10 cm.
- 5 Potential equalization from foundation grounding connection to system (provided by the customer).

- 6 In compliance with DIN EN 14 010, 10 cm wide yellow-black markings compliant to ISO 3864 must be applied by the customer with a distance of 90 cm to the edge of the platform in the access area to mark the danger zone in front of the supporting surface of the upper platform edge (see „Load Plan“ Page 2).
- 7 L = Limousine / S = Station wagon
- 8 Must be at least as high as the greatest car height + 5 cm.

Page 1
Section
Dimensions
Car data

Page 2
Width dim.
Function
Approach
Load plan

Page 3
Electrical
installation
Technical
data

Page 4
To be performed
by the
customer
Description

Width dimensions

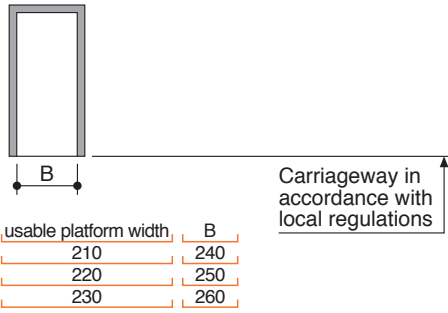

Function

System lifted

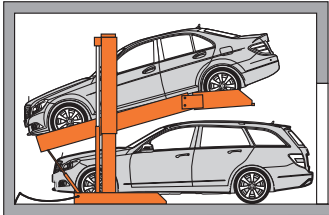

System lowered

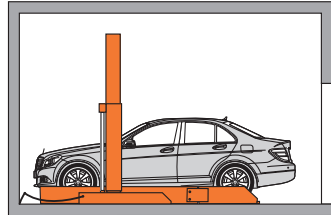

Before lowering the platform, the vehicle parked on the lower parking space must be driven off!

Approach

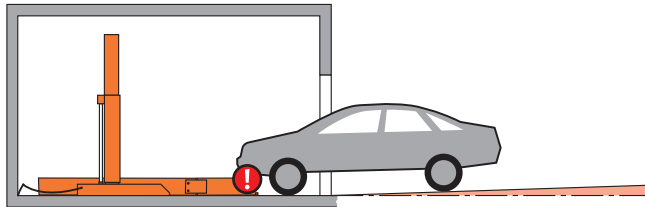

maximum descending slope 4 %

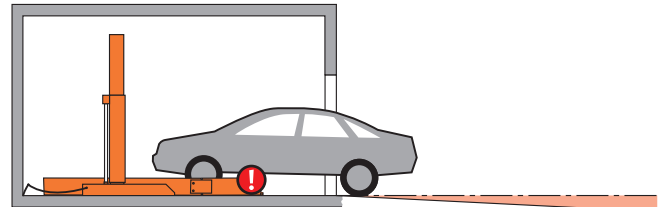

maximum ascending slope 14 %

! The illustrated maximum approach angles must not be exceeded. Incorrect approach angles will cause serious manoeuvring & positioning problems on the parking system for which the local agency of KLAUS Multiparking accepts no responsibility.

Load plan

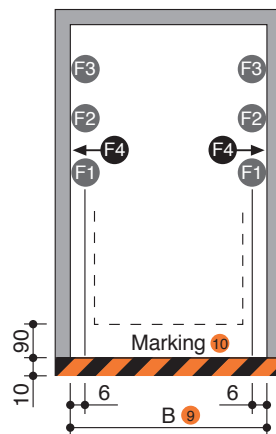
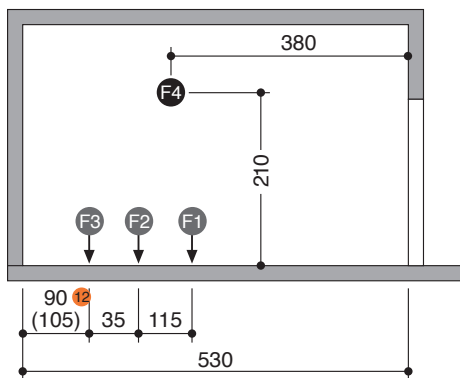

platform load	F1	F2	F3	F4	¹¹
2500 kg	-0,5	+22	-11,5	±1	

! Units are dowelled to the floor. Drilling depth: approx. 15 cm.
Floor and walls are to be made of concrete (quality minimum C20/25)!

The dimensions for the points of support are rounded values. If the exact position is required, please contact KLAUS Multiparking.

- ⁹ Dimension B see above
- ¹⁰ Marking compliant to ISO 3864 (colors used in this illustration are not ISO 3864 compliant)
- ¹¹ All forces in kN
- ¹² Version 1 and 2 see page 1

Electrical installation

Installation diagram

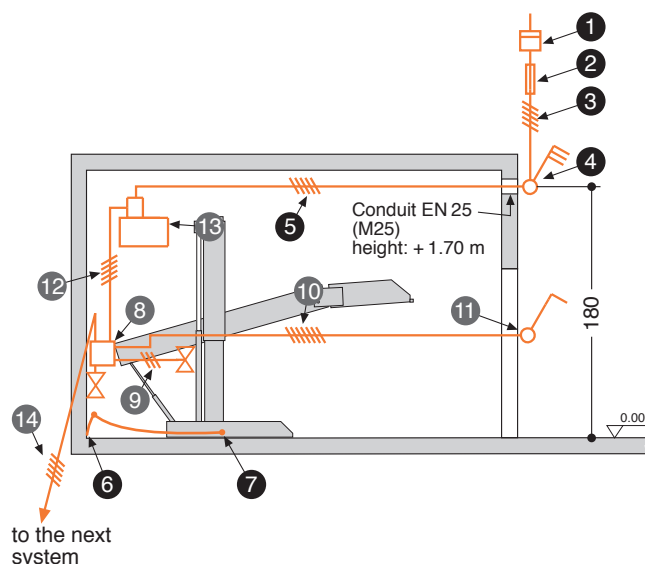

Electrical data (to be performed by the customer)

No.	Quantity	Description	Position	Frequency
1	1	Electricity meter	in the supply line	
2	1	Main fuse: 3 x fuse 16 A (slow) or circuit breaker 3 x 16 A (trigger characteristic K or C)	in the supply line	1 per unit
3	1	Supply line 5 x 2.5 mm ² (3 PH + N + PE) with marked wire and protective conductor	to main switch	1 per unit
4	1	Lockable main switch	defined at the plan evaluation	1 per unit
5	1	Supply line 5 x 2.5 mm ² (3 PH + N + PE) with marked wire and protective conductor	from main switch to unit	1 per unit
6	every 10 m	Foundation earth connector	corner pit floor	
7	1	Equipotential bonding in accordance with DIN EN 60204 from foundation earth connector to the system		1 per system

Electrical data (included in delivery of KLAUS Multiparking)

No.	Description
8	Terminal box
9	Control line 3 x 0.75 mm ² (PH + N + PE)
10	Control line 7 x 1.5 mm ² with marked wire and protective conductor
11	Operating device
12	Control line 5 x 1.5 mm ² with marked wire and protective conductor
13	Hydraulic unit 3.0 kW, three-phase current, 230/400 V / 50 Hz
14	Control line 5 x 1.5 mm ² with marked wire and protective conductor

Technical data

Field of application

By default, the system can only be used for a fixed number of users.

Units

Low-noise power units mounted to rubber-bonded-to metal mountings are installed. Nevertheless we recommend that parking system's garage be built separately from the dwelling.

Available documents

- wall recess plans
- maintenance offer/contract
- declaration of conformity
- test sheet on airborne and slid-borne sound

Building application documents

According to LBO and GaVo (garage regulations) the Multiparking systems are subject to approval. We will provide the required building application documents.

Corrosion protection

See separate sheet regarding corrosion protection.

Care

To avoid damages resulting from corrosion, make sure to follow our cleaning and care instructions and to provide good ventilation of your garage.

Railings

If the permissible drop opening is exceeded, railings are to be mounted on the systems. If there are traffic routes next to or behind the installations, railings compliant to DIN EN ISO 13857 must be installed by the customer. Railings must also be in place during construction.

Environmental conditions

Environmental conditions for the area of multiparking systems: Temperature range –10 to +40° C. Relative humidity 50% at a maximum outside temperature of +40° C.

If lifting or lowering times are specified, they refer to an environmental temperature of +10° C and with the system set up directly next to the hydraulic unit. At lower temperatures or with longer hydraulic lines, these times increase.

CE Certification

The systems offered correspond to DIN EN 14010 and the EC Machinery Directive 2006/42/EG.

Sound insulation

According to DIN 4109 (Sound insulation in buildings), para. 4, annotation 4, KLAUS Multiparkers are part of the building services (garage systems).

Normal sound insulation:

DIN 4109, para. 4, Sound insulation against noises from building services.

Table 4 in para. 4.1 contains the permissible sound level values emitted from building services for personal living and working areas. According to line 2 the maximum sound level in personal living and working areas must not exceed 30 dB (A). *Noises created by users are not subject to the requirements (see table 4, DIN 4109).*

The following measures are to be taken to comply with this value:

- Sound protection package according to offer/order (KLAUS Multiparking GmbH)
- Minimum sound insulation of building $R'_w = 57$ dB (to be provided by customer)

Increased sound insulation (special agreement):

Draft DIN 4109-10, Information on planning and execution, proposals for increased sound insulation.

Agreement: Maximum sound level in personal living and working areas 25 dB (A). *Noises created by users are not subject to the requirements (see table 4, DIN 4109).*

The following measures are to be taken to comply with this value:

- Sound protection package according to offer/order (KLAUS Multiparking GmbH)
- Minimum sound insulation of building $R'_w = 62$ dB (to be provided by customer)

Note: User noises are noises created by individual users in our Multiparking systems. These can be noises from accessing the platforms, slamming of vehicle doors, motor and brake noises.

Page 1
Section
Dimensions
Car data

Page 2
Width dim.
Function
Approach
Load plan

Page 3
Electrical installation
Technical data

Page 4
To be performed by the customer
Description

To be performed by the customer

Safety fences

Any constraints that may be necessary according to DIN EN ISO 13857 in order to provide protection, for pathways directly in front, next to or behind the unit. This is also valid during construction.

Numbering of parking spaces

Consecutive numbering of parking spaces.

Building services

Any required lighting, ventilation, fire extinguishing and fire alarm systems as well as clarification and compliance with the relevant regulatory requirements.

Marking

According to DIN EN 14 010, a warning that identifies this danger area must be placed in the entrance area that conforms to ISO 3864. This must be done according to EN 92/58/EWG for this systems without a pit 90 cm from the edge of the platform.

Wall cuttings

Any necessary wall cuttings according to page 1.

Electrical supply to the main switch / Foundation earth connector

Suitable electrical supply to the main switch and the control wire line must be provided by the customer during installation. The functionality can be monitored on site by our fitters together with the electrician. If this cannot be done during installation for some reason for which the customer is responsible, the customer must commission an electrician at their own expense and risk.

In accordance with DIN EN 60204 (Safety of Machinery. Electrical Equipment), grounding of the steel structure is necessary, provided by the customer (distance between grounding max. 10 m).

Operating device

Cable conduits and recesses for operating device (for double wing doors: please contact the local agency of KLAUS Multiparking).

Operating device exposed

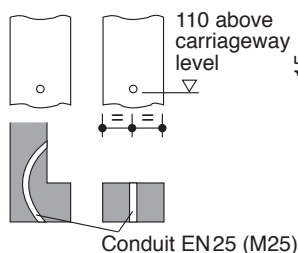

Operating device concealed

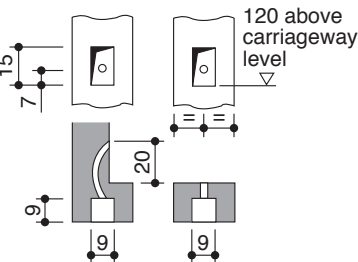

If the following are not included in the quotation, they will also have to be provided / paid for by the customer:

- Mounting of contactor and terminal box to the wall valve, complete wiring of all elements in accordance with the circuit diagram
- Costs for final technical approval by an authorized body
- Main switch
- Control line from main switch to hydraulic unit

Description Single platform (EB)

General description

Multiparking system providing dependent parking spaces for 2 cars one on top of the other each. The lower vehicle parks directly on the floor plate. The vehicle parked on the bottom must be driven out before lowering the platform.

Dimensions are in accordance with the underlying dimensions of height and width

The upper vehicle is driven onto and parked on an inclined platform with a slope of approx. 5 %).

Vehicles are positioned on the upper parking space using wheel stops on the right side (adjust according to operating instructions).

Operation via operating device with hold-to-run-device, safety mechanism activated by a master key and push-button.

The operating elements are usually mounted to an extension arm.

Operating instructions are attached to each operator's stand.

For garages with doors at the front of the parking system the special dimensional requirements have to be taken into account.

Multiparking system consisting of:

- 2 steel pillars with base plates (mounted on the floor)
- 2 sliding platforms (mounted to the steel pillars with sliding bearings)
- 1 platform
- 1 telescopic taught rod between platform and base plates, a mechanic synchronization control system (to ensure synchronous operation of the sliding platforms while lowering and lifting the platform)
- 1 hydraulic cylinder
- 1 automatic mechanic locking systeme (prevents accidental lowering of the platform from its upper limit position)
- Dowels, screws, connecting elements, bolts, etc.
- The platforms and parking spaces are end-to-end accessible for parking!

Platforms consisting of:

- Platform base sections
- Adjustable wheel stops
- Canted access plates
- Side members
- Cross members
- Screws, nuts, washers, distance tubes, etc.

Hydraulic system consisting of:

- Hydraulic cylinder
- Solenoid valve
- Safety valve
- Hydraulic conduits
- Screwed joints
- High-pressure hoses
- Installation material

Electric system consisting of:

- Operating device (Emergency Stop, lock, 1 master key per parking space, push-button)
- Terminal box at wall valve
- Electrical locking device

Hydraulic unit consisting of:

- Hydraulic power unit (low-noise, installed onto a console with a rubber-bonded-to-metal mounting)
- Hydraulic oil reservoir
- Oil filling
- Internal geared wheel pump
- Pump holder
- Clutch
- 3-phase-AC-motor
- Contactor (with thermal overcurrent relay and control fuse)
- Test manometer
- Pressure relief valve
- Hydraulic hoses (which reduce noise transmission onto the hydraulic pipe)

We reserve the right to change this specification without further notice

KLAUS Multiparking reserves the right in the course of technical progress to use newer or other technologies, systems, processes, procedures or standards in the fulfillment of their obligations other than those originally offered provided the customer derives no disadvantage from their so doing.