

Page 1
Section
Dimensions
Car data
Page 2
Width dimensions
Page 3
Width dimensions
Approach
Free spaces
Page 4
Function
Load plan
Page 5
Rails
Page 6
Electrical installation
Technical data
Page 7
To be performed by the customer
Description
Page 8
Description



**KLAUS Multiparking GmbH**  
 Hermann-Krum-Straße 2  
 D-88319 Aitrach  
 Fon +49 (0) 75 65 508-0  
 Fax +49 (0) 75 65 508-88  
 info@multiparking.com  
 www.multiparking.com

**PRODUCT DATA**



**trendvario 4000**

2000 kg<sup>1</sup> / 2600 kg<sup>2</sup>

**Loadable up to 2600 kg!** Single parking spaces can also be upgraded to handle heavier loads at a later date!

**Dimensions**

Tolerances for space requirements +<sup>3</sup>/<sub>0</sub>.<sup>3</sup>  
 Dimensions in cm.

**Suitable for**

Standard passenger cars:  
 Limousine, station wagon, SUV, van  
 according to clearance and maximal  
 surface load.

	Standard	Special <sup>2</sup>
width	190 cm <sup>4</sup>	190 cm <sup>4</sup>
weight	max. 2000 kg	max. 2600 kg
wheel load	max. 500 kg	max. 650 kg

**Clearance profile**

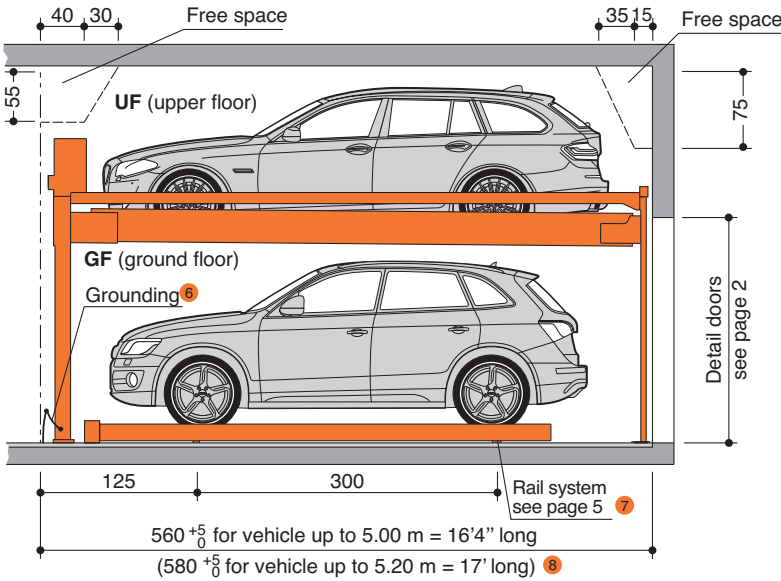
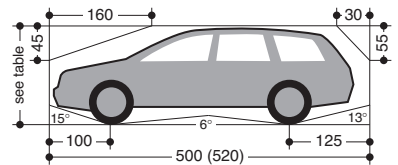

**4000-160**

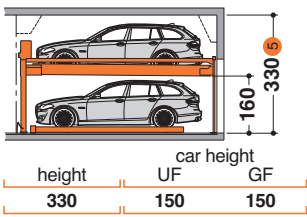

**4000-175**

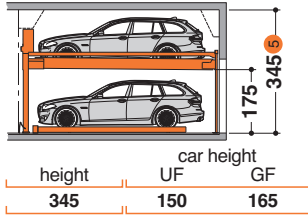

**4000-180**

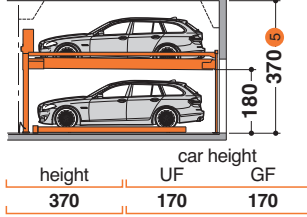

**4000-185**

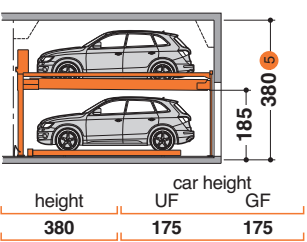

**4000-210**

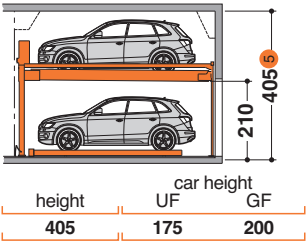

**4000-215**

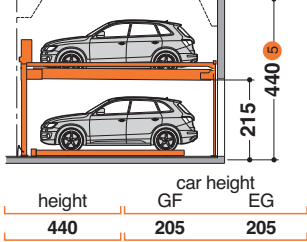

**Combination 4200 with 4000**

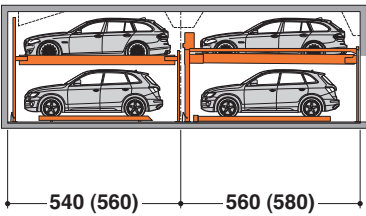

**Combination 4100 with 4000**

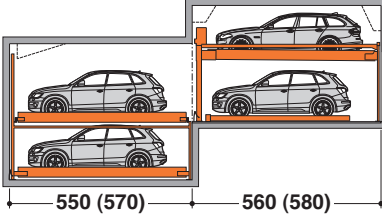

**Combination 4300 with 4000**

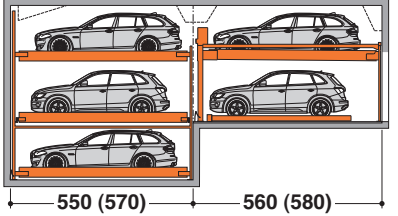

- Standard type
  - Special system: maximum load for extra charge.
  - To follow the minimum finished dimensions, make sure to consider the tolerances according to VOB, part C (DIN 18330 and 18331) and the DIN 18202.
  - Car width for platform width 230 cm. If wider platforms are used it is also possible to park wider cars.
  - If height H is larger, vehicles with the maximum height as applicable for the GF can be parked on the UF, otherwise there will be free space available on the ceiling.
  - Potential equalization from foundation grounding connection to system (provided by the customer).
  - Tolerances for the evenness of the carriageway (floor) must be strictly complied with in accordance with DIN (=German Industrial Standard) No. 18202, chart 3, line 3.
  - For convenient use of your parking space and due to the fact that the cars keep becoming longer we recommend a length of 580 cm.
- !** If sprinklers are required make sure to provide the necessary free spaces during the planning stage.

- Page 1  
Section  
Dimensions  
Car data
- Page 2  
Width  
dimensions
- Page 3  
Width  
dimensions  
Approach  
Free spaces
- Page 4  
Function  
Load plan
- Page 5  
Rails
- Page 6  
Electrical  
installation  
Technical  
data
- Page 7  
To be performed by the customer  
Description
- Page 8  
Description

## Garages with sliding doors (standard) | Widths dimensions

### Sliding door behind columns

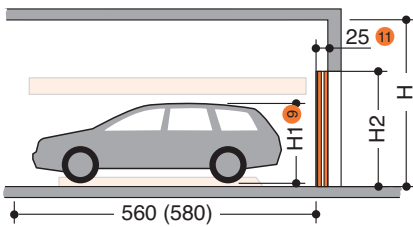

Type	H	H1	H2
4000-160	330	150	210
4000-175	345	165	210
4000-180	370	170	210
4000-185	380	175	210
4000-210	405	200	220
4000-215	440	205	225

### Sliding door between columns

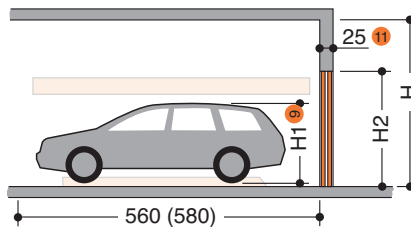

Type	H	H1	H2
4000-160	330	150	220
4000-175	345	165	220
4000-180	370	170	220
4000-185	380	175	220
4000-210	405	200	230
4000-215	440	205	235

### Sliding door in front of columns

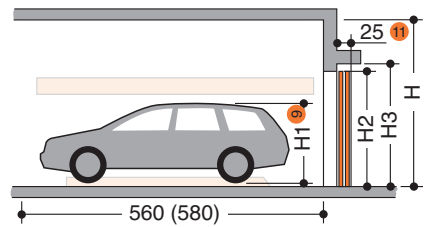

Type	H	H1	H2	H3
4000-160	330	150	210	220
4000-175	345	165	210	220
4000-180	370	170	210	220
4000-185	380	175	210	220
4000-210	405	200	220	230
4000-215	440	205	225	235

### Columns per each grid unit

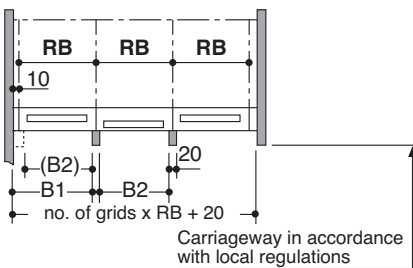

usable platform width

UF	GF	RB	B1	B2
230	220	250	250	230
240	230	260	260	240
250	240	270	270	250
260	250	280	280	260
270	260	290	290	270

### Columns per each grid unit

Not available!

### Columns per each grid unit

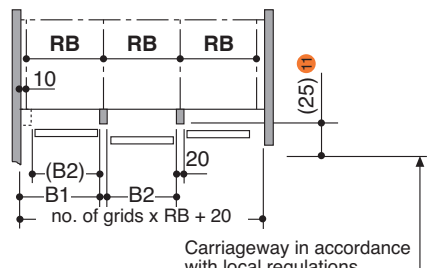

usable platform width

UF	GF	RB	B1	B2
230	220	250	250	230
240	230	260	260	240
250	240	270	270	250
260	250	280	280	260
270	260	290	290	270

### Columns every second grid unit

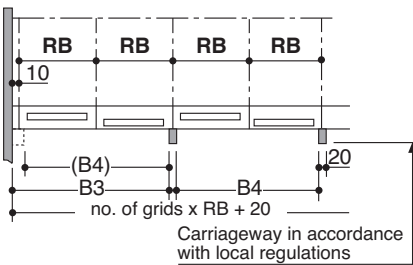

usable platform width

UF	GF	RB	B3	B4
230	220	250	500	480
240	230	260	520	500
250	240	270	540	520
260	250	280	560	540
270	260	290	580	560

### Columns every second grid unit

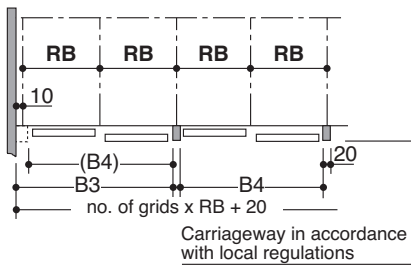

usable platform width

UF	GF	RB	B3	B4
230	220	250	500	480
240	230	260	520	500
250	240	270	540	520
260	250	280	560	540
270	260	290	580	560

### Columns every second grid unit

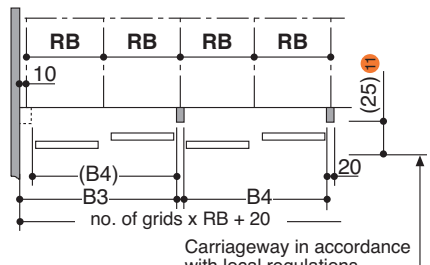

usable platform width

UF	GF	RB	B3	B5
230	220	250	500	480
240	230	260	520	500
250	240	270	540	520
260	250	280	560	540
270	260	290	580	560

**!** According to the BGR 232, an inspection book is required for the commercial use of a gate with electric drive. Prior to commissioning, and then once a year, the gate has to be inspected by an expert and the findings entered in the inspection book. The inspection has to be carried out independent of any maintenance work

For parking boxes on the edges and boxes with intermediate walls we recommend our maximum platform width of 270 cm. Please consider adjoining grids. Problems may occur if smaller platform widths are used (depending on car type, access and individual driving behaviour and capability).

For larger limousines and SUV wider driveways are necessary (in particular on the boxes on the sides due to the missing manoeuvring radius).

- 10** H1 = Height of the vehicle on ground floor platform.
- 11** RB = Grid unit width **must** strictly conform to dimensions quoted!
- 12** Only applies to manually operated doors. The electrically driven doors must have 35 cm.

Page 1  
Section  
Dimensions  
Car data

Page 2  
Width  
dimensions

Page 3  
Width  
dimensions  
Approach  
Free spaces

Page 4  
Function  
Load plan

Page 5  
Rails

Page 6  
Electrical  
installation  
Technical  
data

Page 7  
To be performed by the customer  
Description

Page 8  
Description

## Garages with roll doors | Widths dimensions

### Roll door behind columns

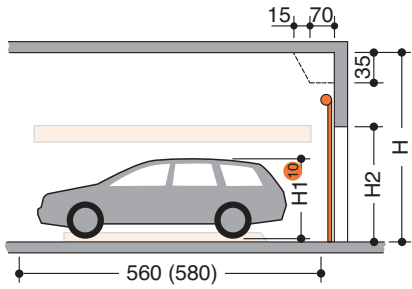

### Columns per each grid unit

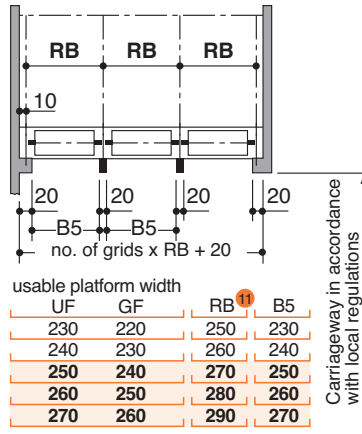

Type	H	H1	H2	roll door height
4000-160	330	150	210	263
4000-175	345	165	210	263
4000-180	370	170	210	263
4000-185	380	175	210	263
4000-210	405	200	220	300
4000-215	440	205	225	300

usable platform width			
UF	GF	RB <sup>11</sup>	B5
230	220	250	230
240	230	260	240
250	240	270	250
260	250	280	260
270	260	290	270

**!** According to the BGR 232, an inspection book is required for the commercial use of a gate with electric drive. Prior to commissioning, and then once a year, the gate has to be inspected by an expert and the findings entered in the inspection book. The inspection has to be carried out independent of any maintenance work

For parking boxes on the edges and boxes with intermediate walls we recommend our maximum platform width of 270 cm. Please consider adjoining grids. Problems may occur if smaller platform widths are used (depending on car type, access and individual driving behaviour and capability).

For larger limousines and SUV wider driveways are necessary (in particular on the boxes on the sides due to the missing manoeuvring radius).

<sup>10</sup> H1 = Height of the vehicle on ground floor platform.

<sup>11</sup> RB = Grid unit width **must** strictly conform to dimensions quoted!

## Grid arrangement

For 2 rows max. 6 grids

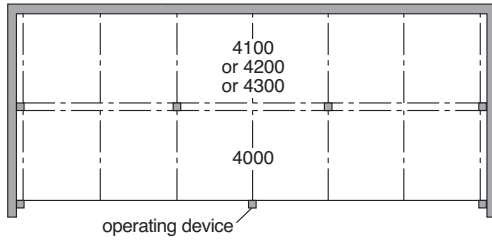

For 3 rows max. 4 grids

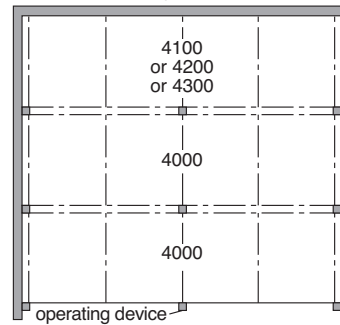

## Approach

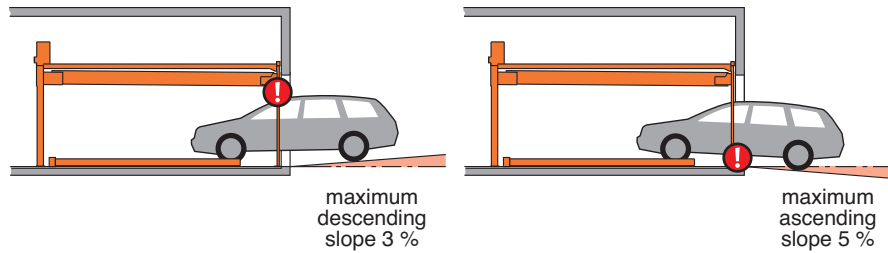

**!** The illustrated maximum approach angles must not be exceeded. Incorrect approach angles will cause serious manoeuvring & positioning problems on the parking system for which the local agency of KLAUS Multiparking accepts no responsibility.

## Longitudinal free space

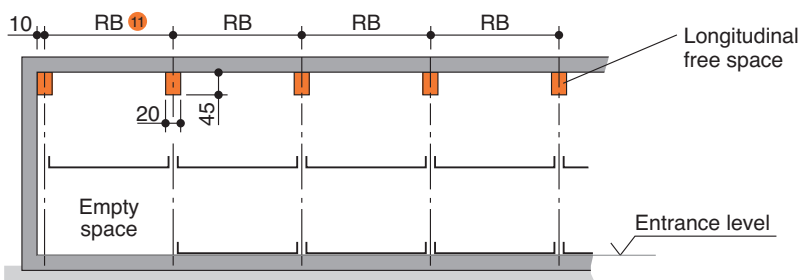

<sup>11</sup> RB = Grid unit width **must** strictly conform to dimensions quoted!

- Page 1  
Section  
Dimensions  
Car data
- Page 2  
Width  
dimensions
- Page 3  
Width  
dimensions  
Approach  
Free spaces
- Page 4  
Function  
Load plan
- Page 5  
Rails
- Page 6  
Electrical  
installation  
Technical  
data
- Page 7  
To be performed by the customer
- Page 8  
Description

## Function with standard numbering and identification of parking levels

e.g. for parking space No. 4: Check first that all doors are closed, then select No. 4 on operating panel.

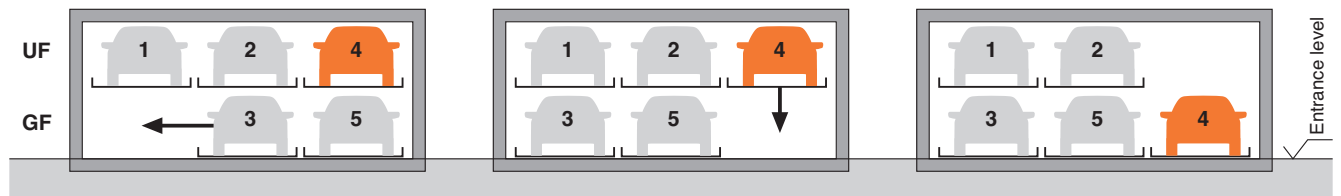

For driving the vehicle off platform No. 4 the ground floor parking platforms are shifted to the left.

The empty space is now below the vehicle which shall be driven off the platform. The platform No. 4 will be lowered.

The vehicle on platform No. 4 can now be driven off the platform.

## Load plan

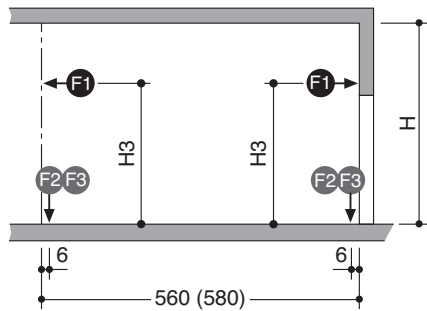

Type	H	H3
4000-160	330	210
4000-175	345	225
4000-180	370	230
4000-185	380	235
4000-210	405	260
4000-215	440	265

### Load plan – top view

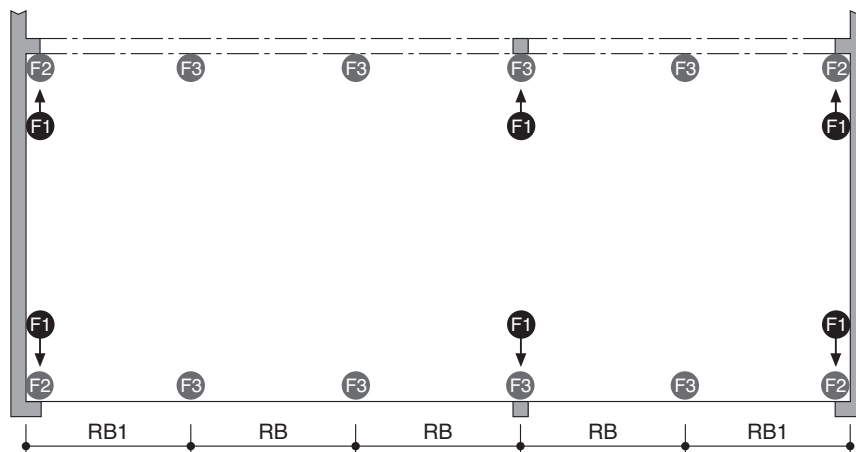

usable platform width	RB <sup>11</sup>	RB1	RB2
230	250	260	135
240	260	270	140
250	270	280	145
260	280	290	150
270	290	300	155

platform load	F1	F2	F3 <sup>12</sup>
2000 kg	±0,5	+8,5	+17
2600 kg	±0,75	+10	+20

**!** The system is dowelled to floor and walls. The drilling depth in the floor is approx. 15 cm. The drilling depth in the walls is approx. 12 cm.

Floor and walls are to be made of concrete (grade of concrete min. C20/25)!

The dimensions for the points of support are rounded values. If the exact position is required, please contact KLAUS Multiparking.

<sup>11</sup> RB = Grid unit width **must** strictly conform to dimensions quoted!

<sup>12</sup> All forces in kN

- Page 1  
Section  
Dimensions  
Car data
- Page 2  
Width  
dimensions
- Page 3  
Width  
dimensions  
Approach  
Free spaces
- Page 4  
Function  
Load plan
- Page 5  
Rails
- Page 6  
Electrical  
installation  
Technical  
data
- Page 7  
To be performed by the customer  
Description
- Page 8  
Description

## Recess/Rail system

Dependent upon the structural conditions of the garage, several different options are available for installation of the rails.

- Rail load by moving traffic load:
- For surface load 2000 kg: 6,5 kN per wheel
  - For surface load 2600 kg: 8 kN per wheel

### Laying on strip foundation <sup>13</sup>

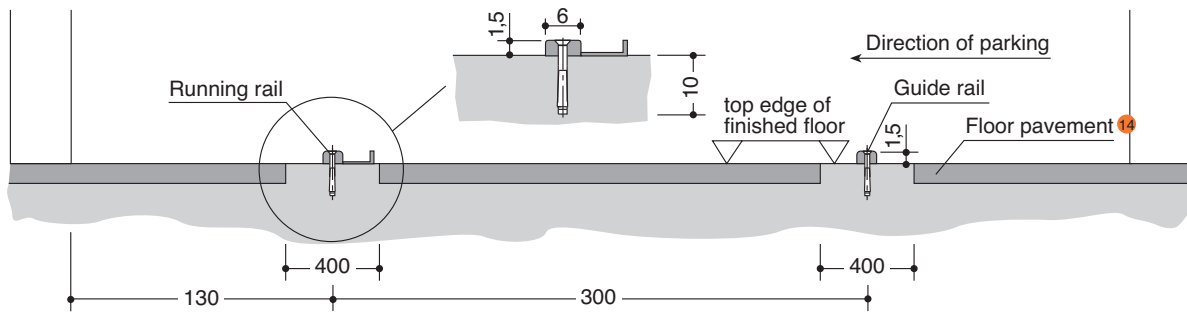

### Laying on finished floor <sup>13</sup>

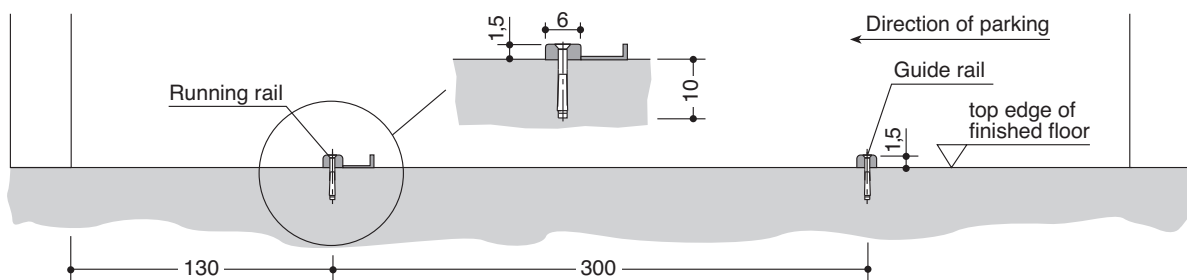

<sup>13</sup> Tolerances for the evenness of the carriageway must be strictly complied with in accordance with DIN (= German Industrial Standard) No. 18202, chart 3, line 3. No expansion joints are permitted within the area of the rail system.

<sup>14</sup> We do not recommend mastic asphalt.

## Evenness and Tolerances (abstract from DIN 18 202, table 3)

The distance between the lower flange of the ParkBoards and the garage ground must therefore not exceed 2 cm. To adhere to the safety regulations and DIN EN 14 010 recommendations and to get the necessary even ground, the tolerances of evenness to DIN 18202, table 3, line 3, must not be exceeded. Therefore exact levelling of the ground by the client is essential.

Column	1	2	3	4	5	6
Line	Reference	Vertical measurement as limits in mm with measuring points distances in m to <sup>15</sup>				
2	Unfinished to surface of covers, subconcrete and subsoils for higher demands, e.g. as foundation for cast plaster floor, industrial soils, paving tiles and slabstone paving, compound floor paving. Finished surfaces for minor purposes, e.g. warehouses, cellar.	0,1	1	4	10	15
3	Finished grounds, e.g. floor pavement serving as foundation for coverings. Coverings, tile coverings, PVC flooring and glued coverings.	5	8	12	15	20
		2	4	10	12	15

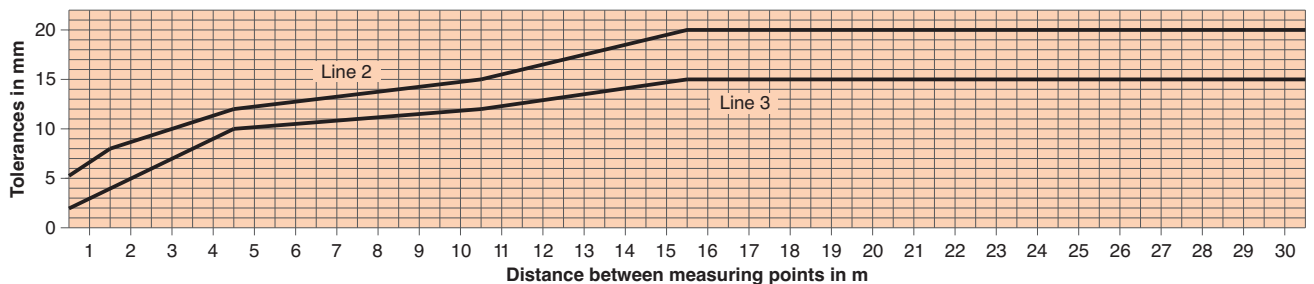

<sup>15</sup> Intermediate values are to be taken out the diagram and must be rounded-off to mm.

Page 1  
Section  
Dimensions  
Car data

Page 2  
Width  
dimensions

Page 3  
Width  
dimensions  
Approach  
Free spaces

Page 4  
Function  
Load plan

Page 5  
Rails

Page 6  
Electrical  
installation  
Technical  
data

Page 7  
To be performed by the customer  
Description

Page 8  
Description

## Electrical data

### Control box

The control box must be accessible at all times from outside!

Dimensions approx. 100 x 100 x 30 cm.

Cutting through of wall from control box to parking system (contact the local agency of KLAUS Multiparking for clarification).

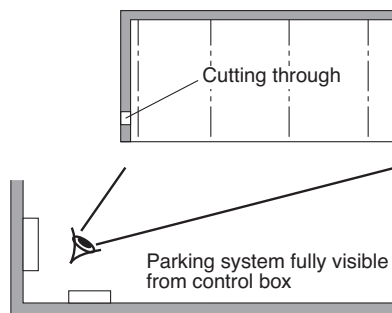

### Electrical supply to the control box / Foundation earth connector

#### Up to 2 rows:

Suitable electrical supply 5 x 2,5 mm<sup>2</sup> (3 PH+N+PE) to control box with mains fuse 3 x 20 A slow or over-current cut-out 3 x 20 A trigger characteristic K or C.

#### With 3 rows:

Suitable electrical supply 5 x 4 mm<sup>2</sup> (3 PH+N+PE) to control box with mains fuse 3 x 25 A slow or over-current cut-out 3 x 25 A trigger characteristic K or C.

Suitable electrical supply to the control box must be provided by the customer during installation. The functionality can be monitored on site by our fitters together with the electrician. If this cannot be done during installation for some reason for which the customer is responsible, the customer must commission an electrician at their own expense and risk.

In accordance with DIN EN 60204 (Safety of Machinery. Electrical Equipment), grounding of the steel structure is necessary, provided by the customer (distance between grounding max. 10 m).

### Operating device

Easy-to-survey positioning (e.g. on column).

Protection against unauthorized use.

May also be recessed in wall if required.

## Technical data

### Field of application

By default, the system can only be used for a fixed number of users.

If different users use the system (e.g. short-time parkers in office buildings or hotels) the Multiparking system needs to be adjusted. If required, would you please contact us.

### Available documents

- wall recess plans
- maintenance offer/contract
- declaration of conformity
- test sheet on airborne and slid-borne sound

### Building application documents

According to LBO and GaVo (garage regulations) the Multiparking systems are subject to approval. We will provide the required building application documents.

### Corrosion protection

See separate sheet regarding corrosion protection.

### Care

To avoid damages resulting from corrosion, make sure to follow our cleaning and care instructions and to provide good ventilation of your garage.

### Environmental conditions

Environmental conditions for the area of multiparking systems: Temperature range –10 to +40° C. Relative humidity 50% at a maximum outside temperature of +40° C.

If lifting or lowering times are specified, they refer to an environmental temperature of +10° C and with the system set up directly next to the hydraulic unit. At lower temperatures or with longer hydraulic lines, these times increase.

### Electrically driven doors

In accordance with BGR 232 commercially used power-driven doors must be subjected to annual inspections. We urgently recommend concluding a maintenance agreement that includes this service for the entire system.

### Numbering

Standard numbering of the parking spaces:



Different numbering is only possible at extra cost

Please take note of the following specifications:

- In general, the empty space must be arranged to the left.
- The numbers must be provided 8 – 10 weeks before the delivery date.

### CE Certification

The systems offered correspond to DIN EN 14010 and the EC Machinery Directive 2006/42/EG.

### Sound insulation

According to DIN 4109 (Sound insulation in buildings), para. 4, annotation 4, KLAUS Multiparkers are part of the building services (garage systems).

#### Normal sound insulation:

DIN 4109, para. 4, Sound insulation against noises from building services.

Table 4 in para. 4.1 contains the permissible sound level values emitted from building services for personal living and working areas. According to line 2 the maximum sound level in personal living and working areas must not exceed 30 dB (A).

*Noises created by users are not subject to the requirements (see table 4, DIN 4109).*

The following measures are to be taken to comply with this value:

- Sound protection package according to offer/order (KLAUS Multiparking GmbH)
- Minimum sound insulation of building  $R'_w = 57$  dB (to be provided by customer)

#### Increased sound insulation (special agreement):

Draft DIN 4109-10, Information on planning and execution, proposals for increased sound insulation.

Agreement: Maximum sound level in personal living and working areas 25 dB (A). *Noises created by users are not subject to the requirements (see table 4, DIN 4109).*

The following measures are to be taken to comply with this value:

- Sound protection package according to offer/order (KLAUS Multiparking GmbH)
- Minimum sound insulation of building  $R'_w = 62$  dB (to be provided by customer)

Note: User noises are noises created by individual users in our Multiparking systems. These can be noises from accessing the platforms, slamming of vehicle doors, motor and brake noises.

Page 1  
Section  
Dimensions  
Car data

Page 2  
Width  
dimensions

Page 3  
Width  
dimensions  
Approach  
Free spaces

Page 4  
Function  
Load plan

Page 5  
Rails

Page 6  
Electrical  
installation  
Technical  
data

Page 7  
To be performed by the customer  
Description

Page 8  
Description

## To be performed by the customer

### Safety fences

Any constraints that may be necessary according to DIN EN ISO 13857 in order to provide protection, for pathways directly in front, next to or behind the unit. This is also valid during construction.

### Numbering of parking spaces

Consecutive numbering of parking spaces.

### Building services

Any required lighting, ventilation, fire extinguishing and fire alarm systems as well as clarification and compliance with the relevant regulatory requirements.

### Wall cuttings

Any necessary wall cuttings.

### Electrical supply to the control box / Foundation earth connector

Suitable electrical supply to the control box must be provided by the customer during installation. The functionality can be monitored on site by our fitters together with the electrician. If this cannot be done during installation for some reason for which the customer is responsible, the customer must commission an electrician at their own expense and risk.

In accordance with DIN EN 60204 (Safety of Machinery. Electrical Equipment), grounding of the steel structure is necessary, provided by the customer (distance between grounding max. 10 m).

### Door suspension

The lintel height H2 (see page 2) is absolutely necessary. With differing heights, additional fixings are required for extra charge.

### Door shields

The lintel height H2 (see page 2) is absolutely necessary. With differing heights, additional fixings are required for extra charge.

### Floor / Rails

Flooring structure in accordance with our instructions, please see page 5 (recesses, rail systems).

Recesses, tolerances for the evenness of the driving lane must adhere to DIN 18202, sheet 3, line 3.

Stuffing of rail system with cement floor for the whole length.

Bringing in of floor pavement.

### If the following are not included in the quotation, they will also have to be provided / paid for by the customer:

- Costs for final technical approval by an authorized body

## Description

### General description:

Multiparking system providing independent parking spaces for cars, one on top of the other and side by side.

Dimensions are in accordance with the underlying dimensions of height and width.

The parking bays are accessed horizontally (installation deviation  $\pm 1\%$ ).

Along the complete width of the parking automat an approach lane (driving lane in accordance with local regulations) must be available. Parking spaces are arranged on two different levels, one level on top of the other.

The platforms of the upper floor (UF) are moved vertically, the platforms on the ground floor (GF) horizontally. At approach level (GF) there is always one parking space less available. This vacant space is used for shifting the ground floor (GF) parking spaces sideways, thus enabling the upper platform (UF) parking space located above to be lowered to approach/ground level. Consequently, a unit of three parking spaces (1 on the ground floor, 2 on the upper floor) is the smallest unit available for this parking system.

The TrendVario 4000 allows parking of passenger cars and station wagons.

For safety reasons the platforms can only be moved behind electromagnetically locked doors.

All necessary safety devices are installed. This consists mainly of a chain monitoring system, locking lever for the upper platforms and electromagnetic door locks.

The doors can only be opened if the selected parking space has reached the park position.

### A steel framework mounted to the floor consisting of:

- Seriated supports
- Steel pillars with sliding platform supports
- Cross and longitudinal members
- running rails for the transversely movable ground floor (GF) platforms

### Platforms consisting of:

- Side members
- Cross members
- Platform base sections
- 1 wheel stop (on the right per parking space)
- Screws, small parts, etc.

### Lifting device for upper floor (UF) platforms:

- Gear motor
- Chain wheel
- Chains
- Limit switches
- The platforms are suspended on four points and guided along the supports using plastic sliding bearings

### Drive unit of transversely movable platforms on the ground floor (GF):

- Gear motor with chain wheel
- Chains
- Running and guide rollers (low-noise)
- Power supply via cable chain

### Control system:

- Central control panel (operating device) used to select the desired parking space
- With series installation, the doors are opened manually
- If desired, this can also be done using electric motors
- Electric wiring is made from the electric cabinet by the manufacturer

Page 1  
Section  
Dimensions  
Car data

Page 2  
Width  
dimensions

Page 3  
Width  
dimensions  
Approach  
Free spaces

Page 4  
Function  
Load plan

Page 5  
Rails

Page 6  
Electrical  
installation  
Technical  
data

Page 7  
To be performed by the customer  
Description

Page 8  
Description

## Description

### Laterally movable doors:

#### Size

Sliding door, dimensions: approx. 2500 mm x 2000 mm (width x height).

#### Frame

- Frame construction with vertical centre stay bar made from extruded aluminium profiles (anodized, layer thickness approx. 20 µm).
- To open the doors a recessed grip is integrated in the aluminium profile.
- A rubber lip is used for the finishing of the closing edge to the building.

#### Standard door panel

- Perforated steel plate
- Thickness 1mm, RV 5/8, galvanized, layer thickness: approx. 20 µm
  - Ventilation cross-section of the panel approx. 40%
  - Not suitable for outdoor garages

#### Alternative door panel

- Perforated aluminium plate
- Thickness 2mm, RV 5/8 E6/EV1, anodized, layer thickness: approx. 20 µm
  - Ventilation cross-section of the panel approx. 40%
- Beaded steel plate
- Thickness 1mm, galvanized, layer thickness: approx. 20 µm.
  - additional power coating, layer thickness: approx. 25 µm on the outside and approx. 12 µm on the inside
  - Colour options for the outside (building view):  
RAL 1015 (light ivory), RAL 3003 (ruby),  
RAL 5014 (pigeon blue), RAL 6005 (moss green),  
RAL 7016 (charcoal grey), RAL 7035 (light grey),  
RAL 7040 (window grey), RAL 8014 (sepia),  
RAL 9006 (white aluminium), RAL 9016 (traffic white)
  - Inside of the gates in light grey

#### Plain aluminium sheet

- Thickness 2mm, E6/EV1, anodized, layer thickness: approx. 20 µm

#### Wooden panelling

- Nordic spruce in grade A
- vertical tongue and groove boards
- preimpregnated colourless

#### Laminated safety glass

- Laminated safety glass made from single pane safety glass 8/4mm

#### Running rails

- The running gear of each doors consists of 2 twin-pair rolling gadgets, adjustable in height
- The running rails of the doors are fixed to brackets or the concrete lintel, or on a building-specific door suspension using ceiling fittings
- The guide consists of 2 plastic rollers mounted to a base plate, which is dowelled to the floor
- Running rails, ceiling fittings and guide roller base plate are hot-dip galvanized

#### Door actuation

##### Standard:

- Manually, i.e. the door is opened and closed by hand

##### Alternatively:

- Electric drive via electric motor mounted to the rail system at the turning point of the sliding doors. The drive pinion engages into the chain mounted to the door.

For safety reasons the movement of the platforms is always made behind locked doors. Position sensing, i.e. "door open" and "door closed" is effected by electric signalers.

#### Separation (if necessary):

- Upon request

#### Please note:

Door panels (on the side, cover for running rails, etc.) and door suspensions are not included in the standard version but can be delivered against surcharge as special equipment.

## We reserve the right to change this specification without further notice

KLAUS Multiparking reserves the right in the course of technical progress to use newer or other technologies, systems, processes, procedures or standards in the fulfillment of their obligations other than those originally offered provided the customer derives no disadvantage from their so doing.